

ORIMA®

**2026
Baltikumi HINNAKIRI**



ORIMA®
The Finnish Quality
Since 1960



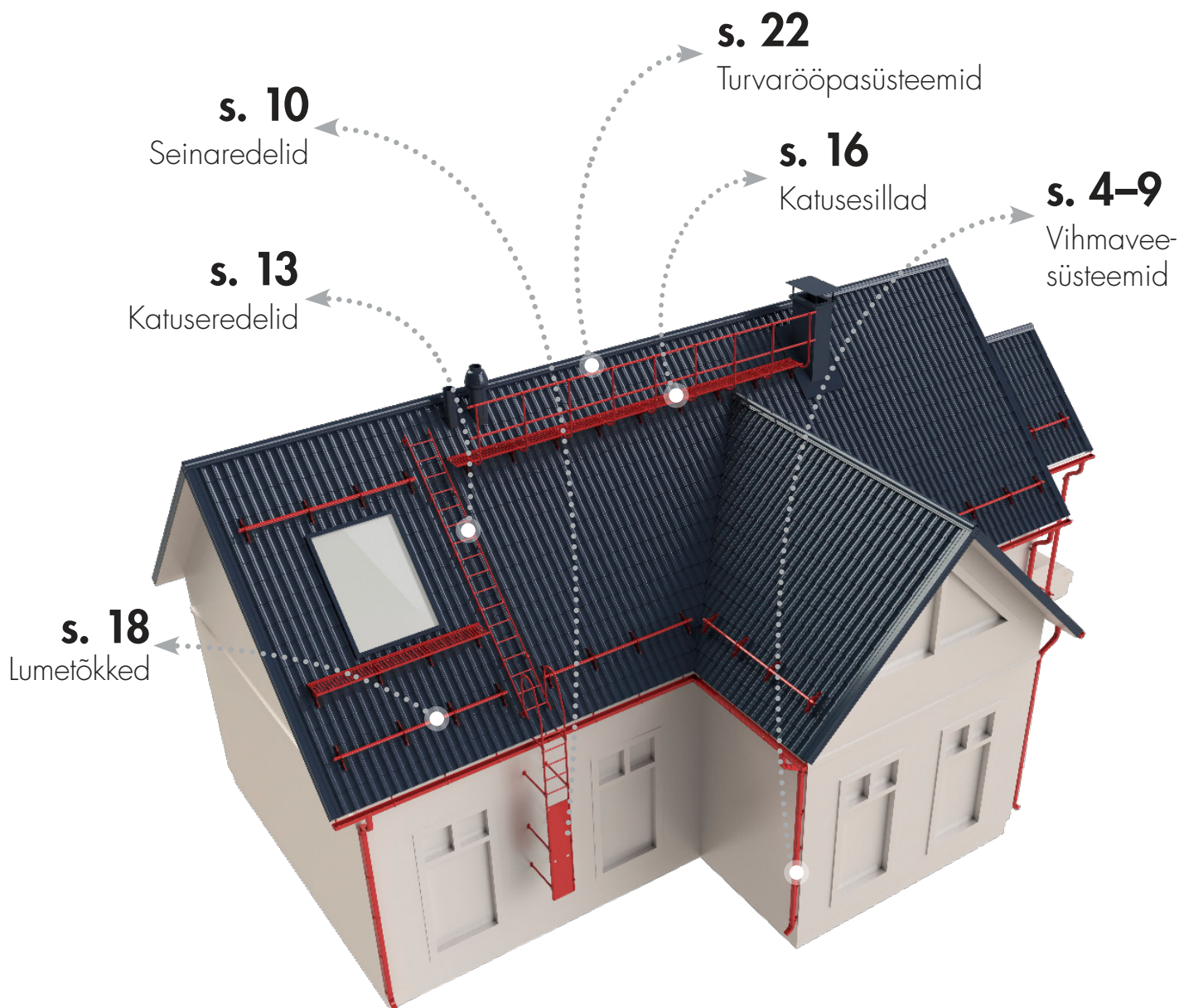

SISUKORD

| | |
|-------------------------------------|----|
| Vihmaveesüsteemid..... | 4 |
| P13, P87, P10 | 4 |
| K12, K9x9..... | 6 |
| P10 Kortsutatud põlvedega..... | 8 |
| Tehniliste juhendite lehekülg | 9 |
| Seinaredeli..... | 10 |
| Evakuatsiooniredelid | 12 |
| Katuseredelid..... | 13 |
| Katusesillad | 16 |
| Lumetõkked | 18 |
| Vörklumetõkked | 20 |
| Katusepiireted..... | 21 |
| Turvarööpad..... | 22 |



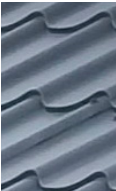
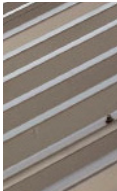

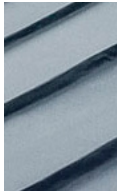
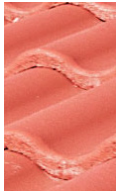
Toodete sobivus erinevatele katustele on märgitud piltidega:





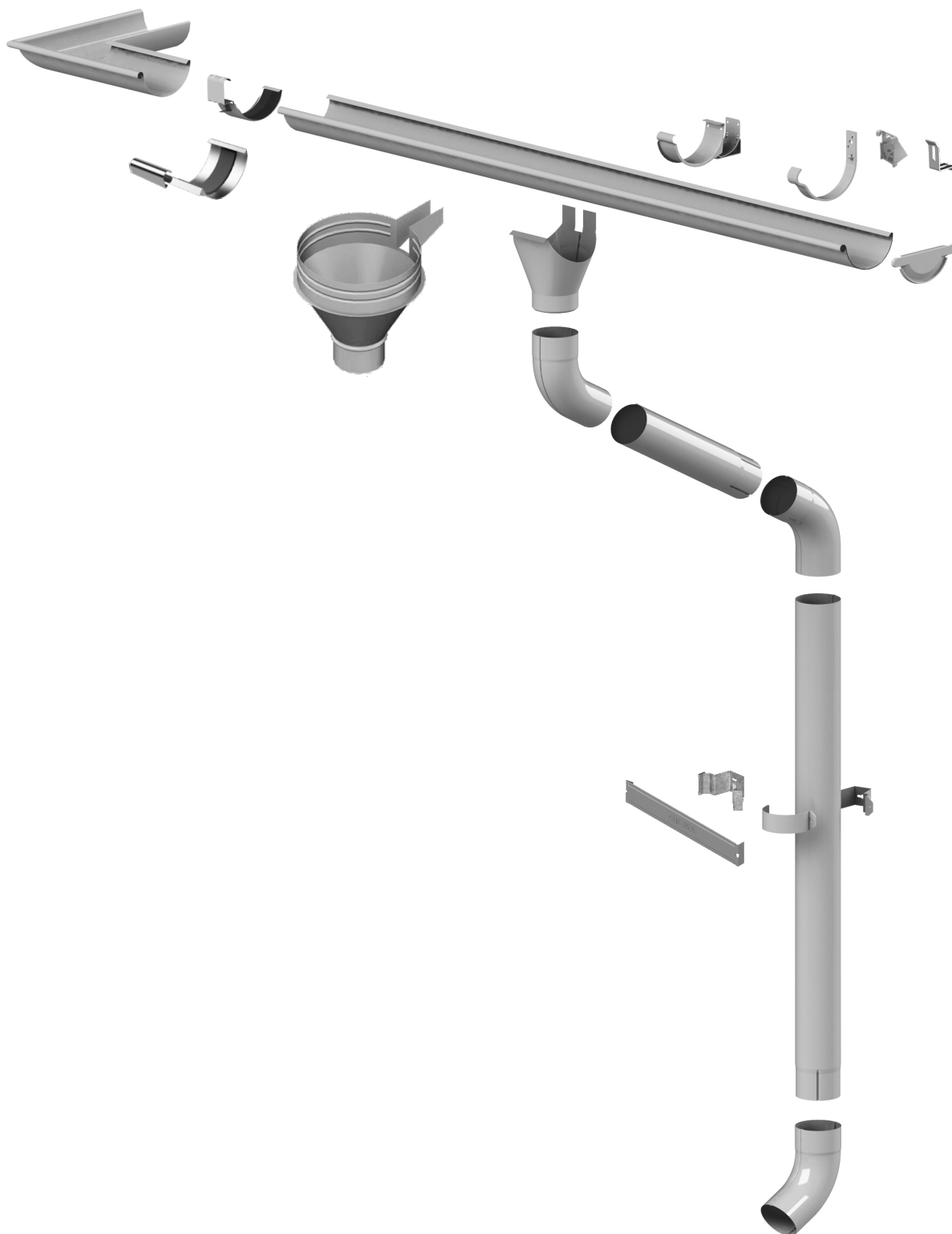





| Kiviprofiil-plekk | Profiilplekk | Bituumen | Valtsprofiil | Kivikatus | Eternit | Cembrit |
|---|---|---|---|--|---|---|
|  |  |  |  |  |  |  |

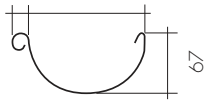



VIHMAVEESÜSTEEMID P13, P87, P10







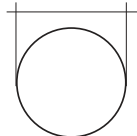

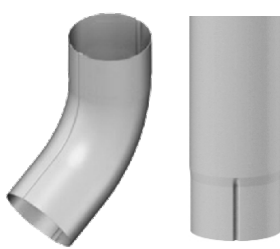

Standardvärvid RR20 RR23 RR32 RR33 RR11 RR21 RR22 RR29 RR750 RR2H3

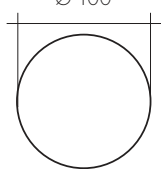
Uus! Mattvärv (RR23, RR2H3, RR32, RR33) +20%; erivärv +20%

| TOODE | MÕÕDUD | TOOTE NR | TARNE-AEG* | | PAIGALDUSVAHE, TOOTEKIRJELDUS | |
|--|---|---|---|-------|---|--|
| P13 renn  | 3 m  | 10150 | 5 | | 16 125 | |
| | 4 m  | 10170 | 5 | |  | |
| | 5 m  | 10010 | 5 | | | |
| | 6 m  | 10020 | 5 | | | |
| | Reguleeritav rennikonks | 10730 | 5 | | | 1 m |
| | Rennikonks | 10110 | 5 | | 1 m | |
| | Konksu tagaosa | 1:4  | 10580 | 5 | | Sirgele rennikonksule, kui otsalaud on kaldega |
| | | 1:3  | 10590 | 5 | | |
| | | 1:2  | 10600 | 5 | | |
| | | 1:1,5  | 10610 | 5 | | |
| | | Rennikonks 1:2,5 | 1:2,5  | 10160 | 5 | 1 m |
| | | Rennikonks 1:3 | 1:3  | 10130 | 5 | 1 m |
| | | Konksu tagaosa: K-mudel | | 11150 | 5 | 1 m |
| | | Rennikonks, pikk | | 10120 | 5 | 1 m |
| | Konksu jätk | | 11140 | 5 | | |
| | Renniots | | 10040 | 5 | | |
| | Rennijätk | | 10050 | 5 | | |
| | Rennijätk 1 osaline | | 10060 | 5 | | |
| | Sisenurk | | 10070 | 5 | | |
| | Välisnurk | | 10080 | 5 | | |

| TOODE | MÕÕDUD | TOOTE NR | TARNE-AEG* | | PAIGALDUSVAHE, TOOTEKIRJELDUS | |
|--|------------------|---|------------|---|-------------------------------|---|
| P87 Vihmaveetoru  | Renni allatulek | 13500 | 5 | | Ø 87 | |
| | P87 Vihmaveetoru | 1,0 m  | 13530 | 5 | |  |
| | | 2,5 m  | 13540 | 5 | | |
| | Pölv | 13520 | 5 | | | |
| | ST kinniti, paar | 13560 | 5 | | 1,5 m | |
| | P87 Lehter | 13610 | 5 | | | |
| | P87 Yliide | 13620 | 10 | | | |
| P87 Reguleeritav väljavooluava | 13670 | 10 | | | | |

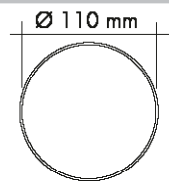
| TOODE | MÕÕDUD | TOOTE NR | TARNE-AEG* | | PAIGALDUSVAHE, TOOTEKIRJELDUS | |
|--|--------------------------------|---|------------|---|--------------------------------|---|
| P10 Vihmaveetoru  | Renni allatulek | 10090 | 5 | | Ø 100 | |
| | P10 Vihmaveetoru | 1,0 m  | 13010 | 5 | |  |
| | | 2,5 m  | 13020 | 5 | | |
| | P10 põlv, sile | 13180 | 5 | | | |
| | P10 suue, sile | 13190 | 5 | | | |
| | P10/K9x9 ST kinnitite paar | 13050 | 5 | | 1,5 m. Painutatav kinnitusvits | |
| | Klamber esiosa | 13040 | 5 | | | |
| | Klambri tagaosa | 12040 | 5 | | galv. | |
| | P10 ST kinniti M2000 | 13030 | 5 | | 1,5 m | |
| | Lehter P10 | 13140 | 5 | | | |
| | P10 Reguleeritav väljavooluava | 13660 | 10 | | | |
| | P10 Yliide | 13680 | 10 | | | |





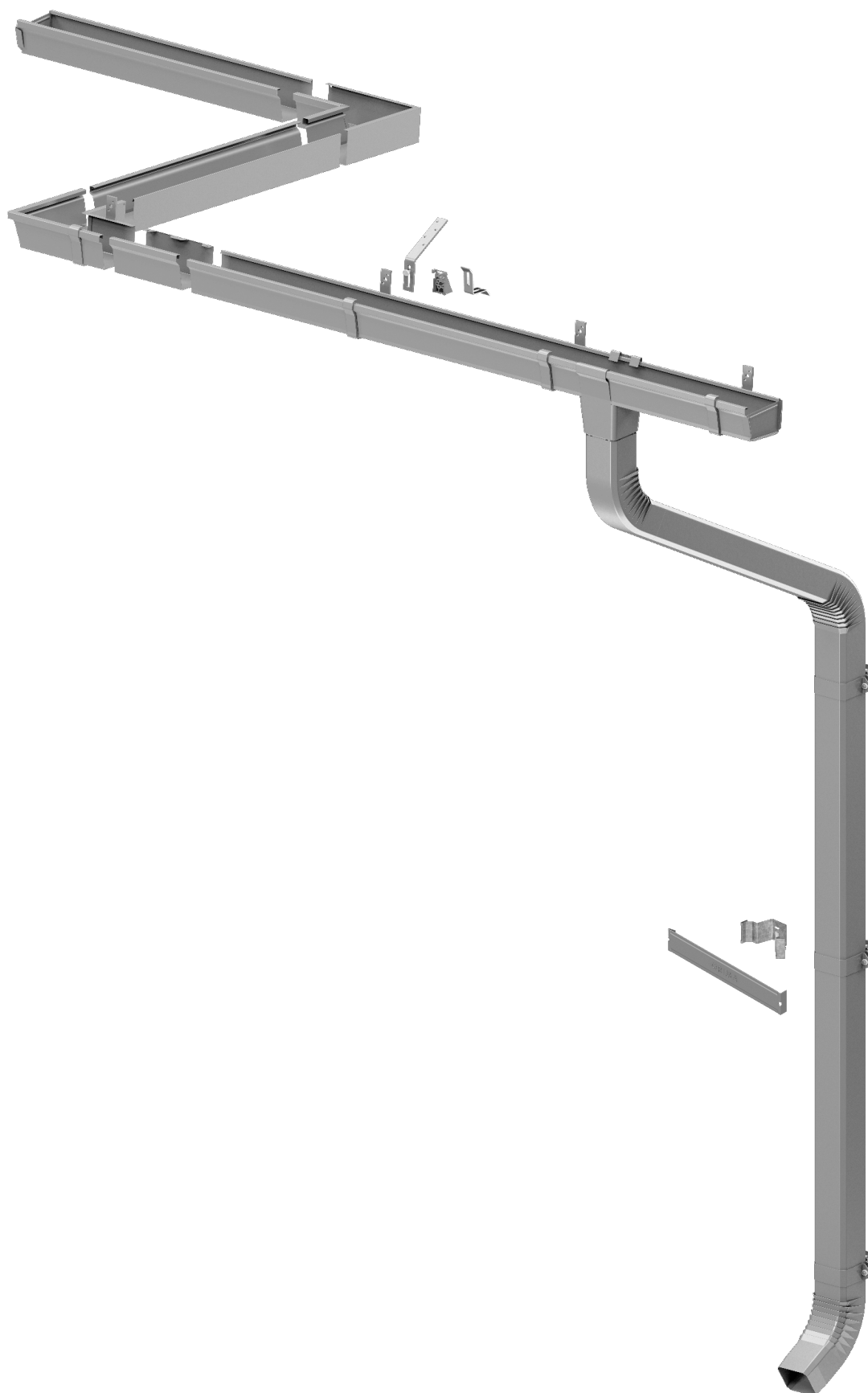





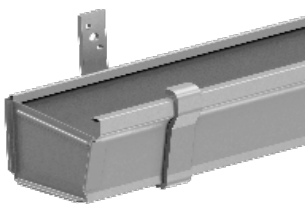

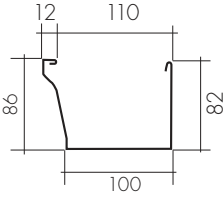
| TOODE | MÕÕDUD | TOOTE NR | TARNE-AEG* | | PAIGALDUSVAHE, TOOTEKIRJELDUS |
|--|----------------------|---|------------|----|---|
| Vihmaveetoru  | Vihmaveetoru, sirge | 2,0 m  | 15010 | 10 |  |
| | Vihmaveetoru | 2,0 m  | 15020 | 10 | |
| | Vihmaveetoru kinniti | | 15030 | 10 | |





VIHMAVEESÜSTEEMID K12, K9x9



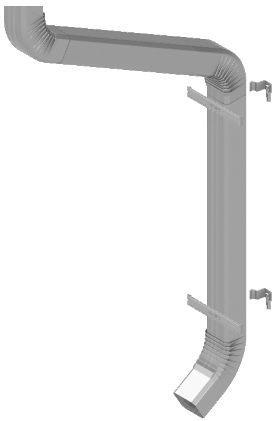
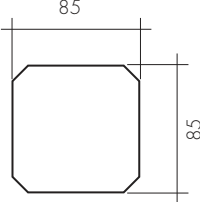

Standardvärvid RR20 RR23 RR32 RR33 RR11 RR21 RR22 RR29 RR750 RR2H3

Uus! Mattvärv (RR23, RR2H3, RR32, RR33) +20%; erivärvid +20%

| TOODE | MÕÖDUD | TOOTE NR | TARNE-AEG* | PAIGALDUSVAHE, TOOTEKIRJELDUS | |
|--|--|---|------------|---|--|
| K12 renn  | 3 m  | 11170 | 5 |  | |
| | K12 renn 4 m  | 11260 | 5 | | |
| | 5 m  | 11010 | 5 | | |
| | 6 m  | 11020 | 5 | | |
| | Rennikonks, sirge | | 11110 | 5 | 1 m |
| | Konksu tagaosa | 1:4  | 10580 | 5 | Sirgele rennikonksule, kui otsalaud on kaldega |
| | | 1:3  | 10590 | 5 | |
| | | 1:2  | 10600 | 5 | |
| | | 1:1,5  | 10610 | 5 | |
| | Rennikonks 1:2,5 | 1:2,5  | 11180 | 5 | 1 m |
| | Rennikonks 1:3 | 1:3  | 11120 | 5 | 1 m |
| | Konksu tagaosa: K-mudel | | 11150 | 5 | 1 m |
| | Sisemine rennikonks | | 11130 | 5 | 1 m, galv. |
| | Konksu jätk | | 11140 | 5 | |
| | Renniots, parem | | 11040 | 5 | |
| Renniots, vasak | | 11050 | 5 | | |
| Sisenurk | | 11070 | 5 | | |
| Välisnurk | | 11080 | 5 | | |

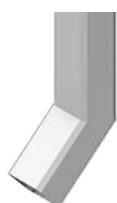
| TOODE | MÕÖDUD | TOOTE NR | TARNE-AEG* | PAIGALDUSVAHE, TOOTEKIRJELDUS |
|---|--|----------|------------|---|
| K9x9 Vihmaveetoru  | Otsast ahenev allatulek | 11090 | 5 |  |
| | K9x9 Vihmaveetoru 1,0 m  | 12010 | 5 | |
| | 2,0 m  | 12020 | 5 | |
| | Toru põlvega 2,6 m 2,6 m  | 12030 | 5 | |
| | Lühike põlv | 12080 | 5 | |
| | Pikk põlv | 12090 | 5 | |
| | K9x9 toru kinnitusklamber M2000 | 12070 | 5 | 1,5 m |
| | P10/K9x9 ST kinnitiite paar | 13050 | 5 | 1,5 m. Painutatav kinnitusvits |
| | Klamber esiosa | 13040 | 5 | |
| | Klambri tagaosa | 12040 | 5 | galv. |
| | Algustükk | 11100 | 5 | |
| | Üleminekupõlv 5 cm | 12100 | 10 |  |
| | Üleminekupõlv 10 cm | 12110 | 10 | |
| | Üleminekupõlv 15 cm | 12120 | 10 | |
| | Üleminekupõlv 20 cm | 12130 | 10 | |
| K9x9 Reguleeritav väljavooluava | 12170 | 10 | | |
| K9x9 Eripõlv | 12970 | 10 | | |

Vihmaveetoru K9x9 mm

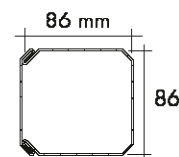

| | | | |
|----------------------|---|-------|----|
| Vihmaveetoru | 2,0 m  | 12150 | 10 |
| Vihmaveetoru kinniti | | 12160 | 10 |



Kohtadesse, kus toru vajab mehaanilist kaitset.

VIHMAVEESÜSTEEMID P10 Kortsutatud põlvedega

ORIMA®

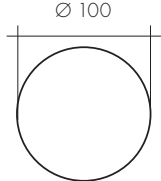
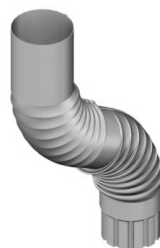
| TOODE | MÕÖDUD | TOOTE NR | TARNE-AEG* | | PAIGALDUSVAHE, TOOTEKIRJELDUS |
|----------------------------|---|----------|------------|--|---|
| P10 Vihmaveetoru | | | | | |
| | 1,0 m  | 13010 | 5 | | |
| P10 Vihmaveetoru | 2,5 m  | 13020 | 5 | | |
| Lühike põlv | | 13070 | 5 | |  |
| Pikk põlv | | 13080 | 5 | | |
| Süliti | | 13090 | 5 | | |
| P10 ST kinniti M2000 | | 13030 | 5 | | |
| P10/K9x9 ST kinnitite paar | | 13050 | 5 | | 1,5 m. Painutatav kinnitusvits |
| | Klamber esiosa | 13040 | 5 | | |
| | Klambri tagaos | 12040 | 5 | | galv. |
| Allatulek | | 10100 | 10 | | |
| Üleminekupõlv 5 cm | | 13100 | 10 | |  |
| Üleminekupõlv 10 cm | | 13110 | 10 | | |
| Üleminekupõlv 15 cm | | 13120 | 10 | | |
| Üleminekupõlv 20 cm | | 13130 | 10 | | |
| P10 Eripõlv | | 13650 | 10 | | |

| TOODE | MÕÖDUD | TOOTE NR | TARNE-AEG* | | PAIGALDUSVAHE, TOOTEKIRJELDUS |
|------------------|---------------------|--------------|------------|----|-------------------------------|
| TERASRULL | | | | | |
| | RR20, -23, -32, -33 | Laius 300 mm | 55530 | 5 | |
| | Erivärvid | Laius 300 mm | 56030 | 10 | |

Standardvärvid RR20 RR23 RR32 RR33 RR11 RR21 RR22 RR29 RR750 RR2H3

Uus! Mattvärvid (RR23, RR2H3, RR32, RR33) +20%; erivärvid +20%

KATUSEVIILU PINDALA JA TORUDE ASUKOHAID

| TORUD | | VIHMAVEETORUDE ARV JA ASUKOHT | | |
|-------|--|-------------------------------|--------------------|--------------------|
| | | | | |
| P87 | | 150 m ² | 100 m ² | 200 m ² |
| P10 | | 225 m ² | 150 m ² | 300 m ² |
| K9x9 | | 190 m ² | 130 m ² | 250 m ² |

KOKKUSOBIVUS

| TORUD | | RENN | |
|--------------|--|------|---|
| | | | |
| P10 | | X | |
| P87 | | X | X |
| K9x9 | | | X |
| Vihmaveetoru | | X | |
| Vihmaveetoru | | | X |

SEINAREDELI

1-osaline,
painutatav
ühendusklamber
20290

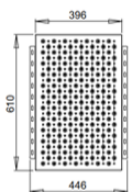
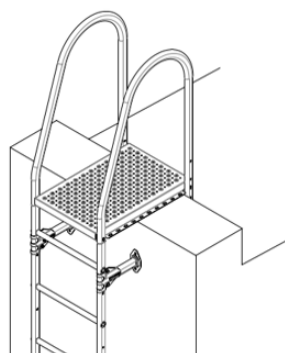
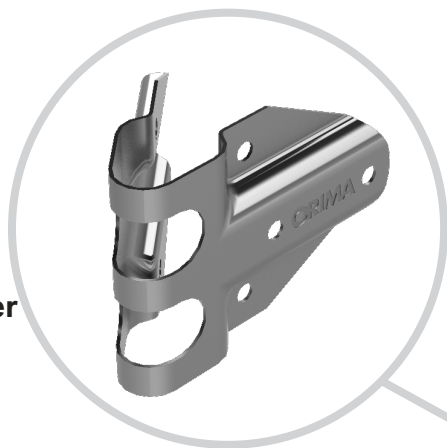



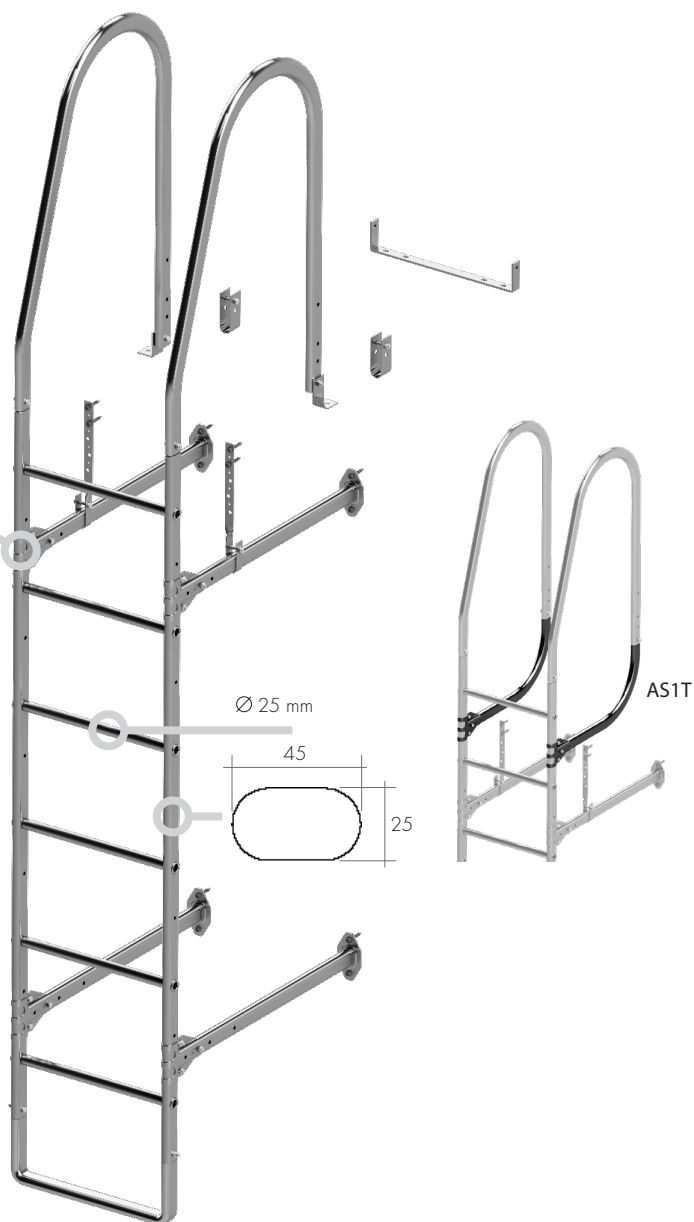



























Katusele ligipääsu platvorm
JOU-242





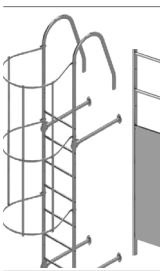

| TOODE | MÖÖDUD | TOOTE NR | TARNE-AEG* | REDELITE ÜHENDUSPIKKUSED | | | | |
|--|---|----------|------------|--------------------------|------|-------|-------|-------|
| | | | | 5,4 m | 6 m | 6,6 m | 7,5 m | 8,4 m |
|  REDELI RAAM | 1,2 m  | 21120 | 5 | | | | | |
| | 2,7 m  | 20040 | 5 | 2 tk | 1 tk | | | |
| | 3,3 m  | 21130 | 5 | | 1 tk | 2 tk | 1 tk | |
| | 4,2 m  | 20070 | 5 | | | | 1 tk | 2 tk |
|  | Plastikust kork, must | 20150 | 5 | | | | | |

Standardvärvid **RR20** **RR23** **RR29** **RR32** **RR33** **RR750** **RR2H3** **RR11** **RR21**



Mativärv (uus!) +10%: **RR23** **RR2H3** **RR32** **RR33** ; erivärvid +10%

| TOODE | MÕÖDUD | TOOTE NR | TARNE-AEG* | TOOTEKIRJELDUS | |
|---|---|--|---|--|---|
| Seinaredeli | | | | | |
|  | 1,2 m  | | | | |
| | 2,7 m  | | + SAS1 | Jalgade arv 4 | |
| | 3,3 m  | | | | |
| | 4,2 m  | | | | |
| | 5,4 m   | 2 x 2,7 m | + SAS1 + SAS1L | Jalgade arv 6 | |
| | 6 m   | 2,7 m + 3,3 m | | | |
| | 6,6 m   | 2 x 3,3 m | | | |
| | 7,5 m   | 3,3 m + 4,2 m | + SAS1 + 2 x SAS1L | Jalgade arv 8 | |
| 8,4 m   | 2 x 4,2 m | | | | |
| AS1 | | | | | |
|  | seinajalad 85–100 cm  | SAS1 | 5 | Sis. ülakaared, 4 seinajalga, ühendusklambrid, (R-kinnitid,) U- ja -klambrid Pisab 3,6 m redeli | |
| | seinajalad 20 cm  | SAS120 | 5 | | |
| | seinajalad 25–40 cm  | SAS140 | 5 | | |
| | seinajalad 55–70 cm  | SAS170 | 5 | | |
| | seinajalad 115–130 cm  | SAS1130 | 5 | | |
| | Ühendusklamber | 20290 | 5 | 1-osaline, painutatav | |
| | Ülakaar | 20080 | 5 | | |
| U-klamber | 20120 | 5 | Ülakaare kinnitamiseks katuse-reledid | | |
| L-klamber | 20130 | 5 | Ülakaare kinnitamiseks katusele | | |
| R-kinniti | 20140 | 5 | Kasutatakse 50 cm pikkustest jalgadest alates | | |
| AS1L | | | | | |
|  | seinajalad 85–100 cm  | SAS1L | 5 | 2 seinajalga ja ühendusklambrid 1 lisakomplekti/3 m | |
| | seinajalad 20 cm  | SAS1L20 | 5 | | |
| | seinajalad 25–40 cm  | SAS1L40 | 5 | | |
| | seinajalad 55–70 cm  | SAS1L70 | 5 | | |
| | seinajalad 115–130 cm  | SAS1L130 | 5 | | |
| AS1T | | | | | |
|  | Ülakaare tugikomplekt | SAS1T | 5 | 2 torutuge ja ühendusklambrid | |
| | Ülakaare tugi (torumudel) | 20540 | 5 | | |
| | Ülakaare tugikomplekt | 35620 | 5 | Toekomplekti paar ülakaarte ja redelite ühendamiseks | |
| | Ülakaare katusesillakinniti | 20260 | 5 | | |
|  | Alakaar | Kõrgus 165 mm | 20250 | 5 | |
| | Paroc-kinniti | | 20640 | 10 | Seinajalgade kinnitamiseks sandwich paneeli külge |
|  | Redeli ronimistöke | Kõrgus 0,9 m  | 20400 | 10 | |
| | | Kõrgus 2,1 m  | 20440 | 10 | |
| | Seljakaar | | 24010 | 10 | Paigaldusvahe 900 mm |
| | Püstlatt 900 mm | | 24020 | 10 | |
| | Seljakaare paigalduskomplekt | | 35271 | 10 | |
| Katusele ligipääsu platvorm | | | JOU-242 | | |

EVAKUATSIOONIREDELID

| TOODE | MÕÖDUD | TOOTEKIRJELDUS |
|---|---|---------------------------------|
| Evakuatsiooniredeli metalljalastega  | 1,2 m  | + SAS8 Jalgade arv 4 |
| | 2,7 m  | |
| | 3,3 m  | + SAS8 + SAS8L Jalgade arv 6 |
| | 4,2 m  | |

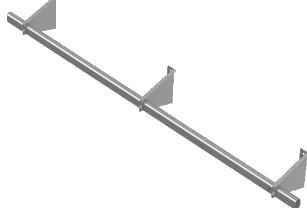
Paigalduskomplektidesse kuuluvad vajalik arv kinniteid ning kokkupanekuks ja kinnituseks vajalikud kruvid ja mutrid.





| TOODE | MÕÖDUD | TOOTE NR | TARNE-AEG* | TOOTEKIRJELDUS |
|---|--|----------|------------|--|
| AS8  | Paigalduskomplekti AS8, Metalljalastega | SAS8 | 5 | Sis. ülemised jalased, ülemised kinnitid ja seinajalad. Piisab 3,0 m redeli pikkusele |
| | Lisakomplekti AS8L, Metalljalastega | SAS8L | 5 | Sis. seinajalad. |
| | Turvaredeli ülemine jalas | 20160 | 5 | |
| | Turvaredeli ülemine kinniti | 20500 | 5 | |
| | Turvaredeli jalas, plekk | 20380 | 5 | |
| AS5  | Kõrvaleastumiskomplekt 1,5 m  | SAS5U | 5 | Sis. Kõrvaleastumistoru ja 3 kõrvaleastumistoru kandurid |
| | Kõrvaleastumistoru kandur | 20970 | 5 | |
| | Kõrvaleastumistoru 1,5 m  | 20630 | 5 | |

| TOODE | MÕÖDUD | TOOTE NR | TARNE-AEG* | REDELITE ÜHENDUSPIKKUSED | | | | |
|---|---|----------|------------|--------------------------|------|-------|-------|-------|
| | | | | 5,4 m | 6 m | 6,6 m | 7,5 m | 8,4 m |
| REDELI RAAM  | 1,2 m  | 21120 | 5 | | | | | |
| | 2,7 m  | 20040 | 5 | 2 tk | 1 tk | | | |
| | 3,3 m  | 21130 | 5 | | 1 tk | 2 tk | 1 tk | |
| | 4,2 m  | 20070 | 5 | | | | 1 tk | 2 tk |
|  | Plastikust kork, must | 20150 | 5 | | | | | |

Standardvärvid **RR20** **RR23** **RR29** **RR32** **RR33** **RR750** **RR2H3** **RR11** **RR21**

Mattvärvid (uus!) +10%: **RR23** **RR2H3** **RR32** **RR33** ; erivärvid +10%

KATUSEREDELID

| TOODE | MÖÖDUD | TOOTE NR | TARNE-AEG* | TOOTEKIRJELDUS |
|---|---|----------|------------|---|
|  | Katuseredel 1,2 m  | 22010 | 5 | Jätkata ka ülekattega. Katuse kalle 8°–45° |
| | Katuseredel 2,4 m  | 22030 | 5 | |
| Katusesilla piirde | 2,4 m  kõrg 0,6 m | SVR | 10 | ei sis. katuseredelit |
| Lisakomplekti piirete | 2,5 m  kõrg 0,6 m | SVRL | 10 | ei sis. katuseredelit |

| TOODE | TOOTE NR | TARNE-AEG* | TOOTEKIRJELDUS |
|-------|----------|------------|----------------|
|-------|----------|------------|----------------|

KR1 C2



K-kinniti 20180 5

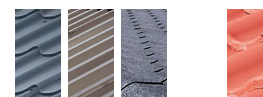

CE klass 2

KR6 C2

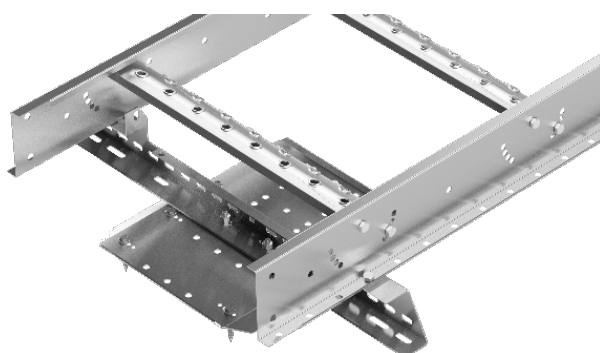

Redeli kõrgendus 20520 5

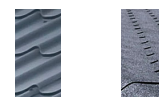

CE Klass 2

Trepi kõrgemale asetamiseks ja liikumise kergendamiseks

Profilikinniti 34280 10



CE Klass 2

Redeli kõrgenduse 20520 alla trapetsprofiilkatusele

KR2 C2

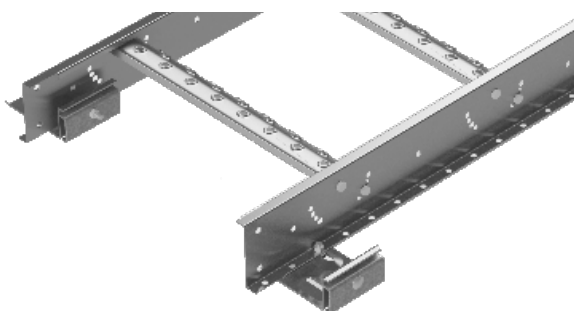

Redeli kinniti profiilile 22156 5



CE Klass 2

2-osaline Materjal Magnelis®

Masinvaltskatusele
Valtside vahe 405-540 mm.
Paigaldusvahe max. 2 m

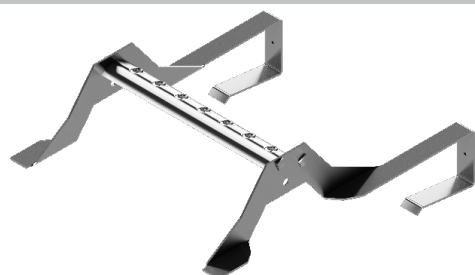

Aste kivikatusele, isekinnituv 23090 10



Ilma CE-märgistusega!
Alla 9m hoonetele

KATUSEREDELID

| TOODE | MÕÖDUD | TOOTE NR | TARNE-AEG* | REDELITE ÜHENDUSPIKKUSED | | | | |
|------------------------|-----------------------|----------|------------|--------------------------|------|-------|-------|-------|
| | | | | 5,4 m | 6 m | 6,6 m | 7,5 m | 8,4 m |
| REDELI RAAM | 1,2 m | 21120 | 5 | | | | | |
| | 2,7 m | 20040 | 5 | 2 tk | 1 tk | | | |
| | 3,3 m | 21130 | 5 | | 1 tk | 2 tk | 1 tk | |
| | 4,2 m | 20070 | 5 | | | | 1 tk | 2 tk |
| | Plastikust kork, must | 20150 | 5 | | | | | |

Paigalduskomplektidesse kuuluvad vajalik arv kinniteid ning kokkupaneuks ja kinnituseks vajalikud kruvid ja mutrid.

| TOODE | MÕÖDUD | TOOTE NR | TARNE-AEG* | TOOTEKIRJELDUS |
|---------------------|------------------------|------------------|------------|---------------------------------------|
| AS3C2 | 3,3 m | + SAS3C2 | | CE Klass 2 |
| | 4,2 m | + SAS3C2 | | |
| | 5,4 m 2,7 m + 2,7 m | + SAS3C2 | | |
| | 6,0 m 2,7 m + 3,3 m | + SAS3C2 + SAS3L | | |
| | 6,6 m 3,3 m + 3,3 m | + SAS3C2 + SAS3L | | |
| | 7,5 m 3,3 m + 4,2 m | + SAS3C2 + SAS3L | | |
| Paigalduskomplektid | Piisab 6 m redeli | SAS3C2 | 5 | Sis. 2 K-kinnitiit ja 10 plastikjalga |
| Lisakomplekt | | SAS3L | 5 | Sis. 2 Plekkjalad |
| MK-jalg | | 20240 | 5 | Paigaldusvahe max. 1,4 m |
| K-kinniti | | 20180 | 5 | Paigaldusvahe max. 5 m |
| Plekkjalas | | 20320 | 5 | |

| TOODE | MÕÖDUD | TOOTE NR | TARNE-AEG* | TOOTEKIRJELDUS |
|---------------------|------------------------|----------------------|------------|---|
| AS3B | 3,3 m | + SAS3B | | CE Klass 2 |
| | 4,2 m | + SAS3B | | |
| | 5,4 m 2,7 m + 2,7 m | + SAS3B + SAS3BL | | |
| | 6,0 m 2,7 m + 3,3 m | + SAS3B + SAS3BL | | |
| | 6,6 m 3,3 m + 3,3 m | + SAS3B + 2 x SAS3BL | | |
| | 7,5 m 3,3 m + 4,2 m | + SAS3B + 3 x SAS3BL | | |
| Paigalduskomplektid | Piisab 4,2 m redeli | SAS3B | 5 | Sis. 4 redeli kõrgendus, 2 K-kinnitiit |
| Lisakomplekt | | SAS3BL | 5 | Sis. 1 Redeli kõrgendus |
| Redeli kõrgendus | | 20520 | 5 | Paigaldusvahe max. 5 m, Tugijalgade vahe max. 1,4 m |
| K-kinniti | | 20180 | 5 | Paigaldusvahe max. 5 m |

Standardvärvid RR20 RR23 RR29 RR32 RR33 RR750 RR2H3 RR11 RR21

Mattvärvid (uus!) +10%: RR23 RR2H3 RR32 RR33 ; erivärvid +10%

| TOODE | MÕÕDUD | TOOTE NR | TARNE-AEG* | | TOOTEKIRJELDUS |
|------------------------|------------------------|--------------------|------------|--|--|
| AS2C2 | 3,3 m | + SAS2C2 | | | CE Klass 2 |
| | 4,2 m | + SAS2C2 | | | |
| | 5,4 m 2,7 m + 2,7 m | + SAS2C2 | | | |
| | 6,0 m 2,7 m + 3,3 m | + SAS2C2 + SAS2LC2 | | | |
| | 6,6 m 3,3 m + 3,3 m | + SAS2C2 + SAS2LC2 | | | |
| | 7,5 m 3,3 m + 4,2 m | + SAS2C2 + SAS2LC2 | | | |
| Paigaldus-komplektid | Piisab 5,1 m redeli | SAS2C2 | 5 | | Sis. 2 valtsplekikinnituse komplekti, 8 plastikjalga |
| Lisakomplekt | 1 komplekt/5 m | SAS2LC2 | 5 | | Sis. 1 valtsplekikinnituse komplekt, 4 plastikjalga |
| Redeli ridakinnitus C2 | | 22440 | 5 | | Klass 2 |
| P-kinniti | | 20420 | 5 | | |
| MK-jalg | | 20240 | 5 | | Paigaldusvahe max. 1,4 m |

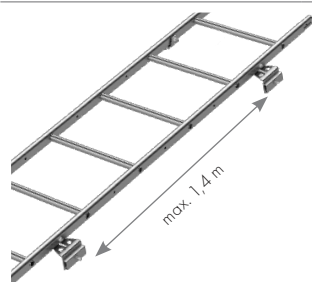

Redeli ridakinnitus (nurkadest)

22060 5

CE Klass 2
2-osaline

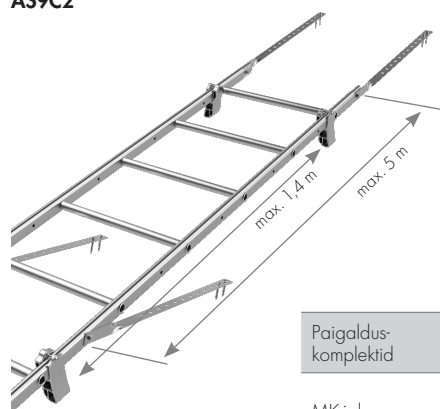
AS9C2



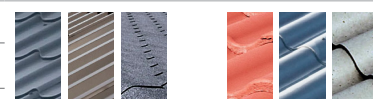



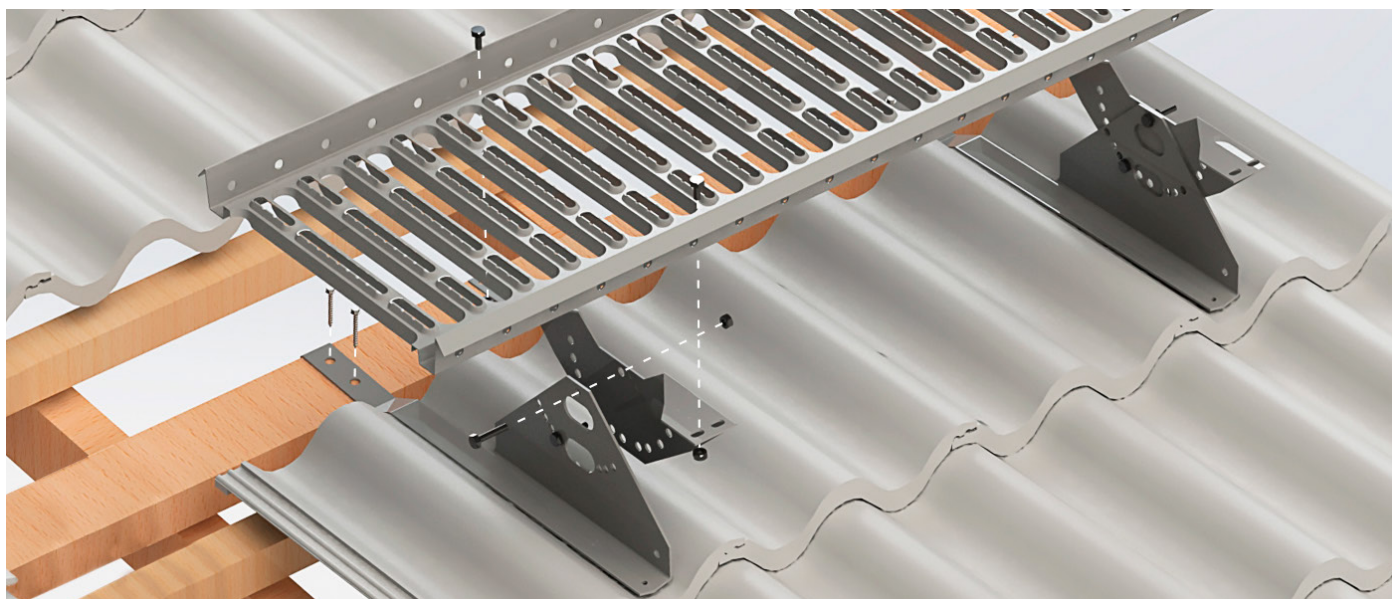

| | | | |
|------------------------|--------------|--|--|
| 3,3 m | + SAS9C2 | | |
| 4,2 m | + SAS9C2 | | |
| 5,4 m 2,7 m + 2,7 m | + 2 x SAS9C2 | | |
| 6,0 m 2,7 m + 3,3 m | + 2 x SAS9C2 | | |
| 6,6 m 3,3 m + 3,3 m | + 2 x SAS9C2 | | |
| 7,5 m 3,3 m + 4,2 m | + 2 x SAS9C2 | | |

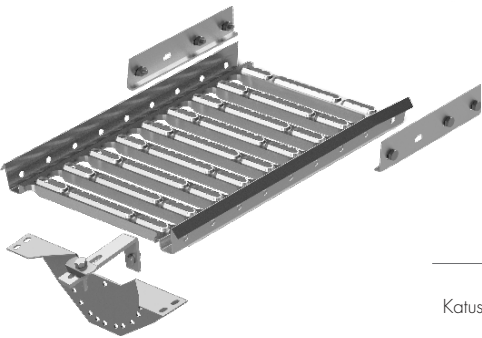
CE Klass 2

| | | | | | |
|----------------------|---------------------|--------|---|--|-------------------------------------|
| Paigaldus-komplektid | Piisab 5,1 m redeli | SAS9C2 | 5 | | Sis. 4 K-kinnitiit, 10 plastikjalga |
| MK-jalg | | 20240 | 5 | | Paigaldusvahe max. 1,4 m |
| K-kinniti | | 20180 | 5 | | Paigaldusvahe max. 5 m |

KATUSESILLAD

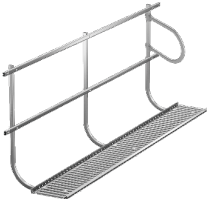









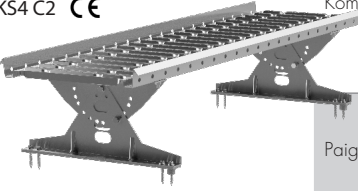

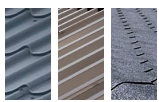





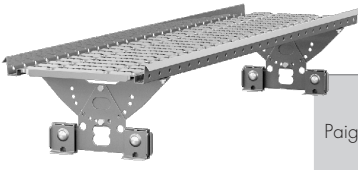





















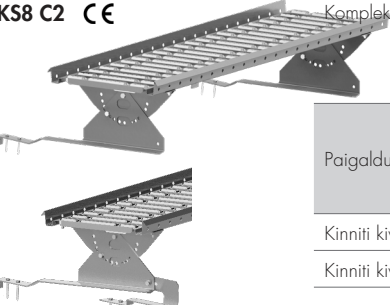







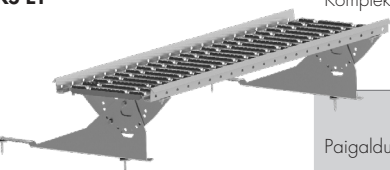





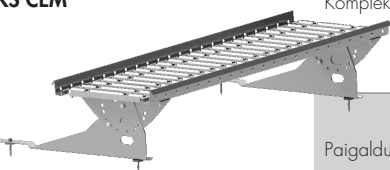

| TOODE | MÖÖDUD | TOOTE NR | TARNE-AEG* | | TOOTEKIRJELDUS |
|---|--|---|------------|----|---------------------|
| Katusesild  | 0,6 m  | 30640 | 5 | | |
| | 1,21 m  | 30010 | 5 | | Laius 350 mm |
| | 2,25 m  | 30200 | 5 | | |
| | 2,97 m  | 30030 | 5 | | |
| Katusesilla kandur | | 30060 | 5 | | Laius 350 mm |
| Katusesilla jäikutükk | | 30040 | 5 | | 1 tk |
| Katusesilla otsatoe komplekt | | 35110 | 5 | | |
|  | Piirete komplekt | 1,2 m  | 35140 | 10 | Ei sis. katusesilda |
|  | Ks-piire | 3,0 m  | SVL | 10 | Ei sis. katusesilda |
| | Otsakaare komplekt | | 35130 | 10 | |

Standardvärvid RR20 RR23 **RR29** RR32 RR33 **RR750** RR2H3 RR11 RR21

Mattvärvid (uus!) +10%: RR23 RR2H3 RR32 **RR33** ; erivärvid +10%

Paigalduskomplektidesse kuuluvad vajalik arv kinniteid ning kokkupanekuks ja kinnituseks vajalikud kruvid ja mutrid.

| TOODE | MÕÕDUD | TOOTE NR | TARNE-AEG* | TOOTEKIRJELDUS | |
|---|--|--|------------|--|----|
| KS4 C2  Komplektid | 1,21 m  | STTOC2 | 5 |  Kinniti paigaldusvahe max 1,2 m | |
| | 2,25 m  | STTNC2 | 5 | | |
| | 2,97 m  | STTFC2 | 5 | | |
| | 1,21 m  | STTOZC2 | 5 | | |
| | Paigalduskomplektid | 2,25 m  | STTNZC2 | | 5 |
| | 2,97 m  | STTFZC2 | 5 | | |
| | Kinniti kiviprofiil-, bituumen- ja profiilkatus 420 mm | 30630 | 5 | | |
| KS3 (C1)  Komplektid | 1,21 m  | STTL | 5 |  Kinniti paigaldusvahe max 1,2 m | |
| | 2,25 m  | STTG | 5 | | |
| | 2,97 m  | STTA | 5 | | |
| | 1,21 m  | STTLZ | 5 | | |
| | Paigalduskomplektid | 2,25 m  | STTGZ | | 5 |
| | 2,97 m  | STTAZ | 5 | | |
| | Rivikinniti paigalduskomplekt klass 1 | 35640 | 5 | | |
| KS3 C2  Komplektid | 1,21 m  | STTLC2 | 5 | | |
| | 2,25 m  | STTGC2 | 5 | | |
| | 2,97 m  | STTAC2 | 5 | | |
| | 1,21 m  | STTLZC2 | 5 | | |
| | Paigalduskomplektid | 2,25 m  | STTGZC2 | | 5 |
| | 2,97 m  | STTAZC2 | 5 | | |
| | Rivikinniti paigalduskomplekt klass 2 | 35820 | 5 | | |
| KS7 C2  Komplektid | 1,21 m  | STTDBC2 | 5 |  Kinniti paigaldusvahe max 1,2 m | |
| | 2,25 m  | STTDA | 5 | | |
| | 2,97 m  | STTD | 5 | | |
| | 1,21 m  | STTDBZC2 | 5 | | |
| | Paigalduskomplektid | 2,25 m  | STTDAZ | | 5 |
| | 2,97 m  | STTDZ | 5 | | |
| | Kinniti kiviprofiil-, bituumen- ja profiilkatus | 30530 | 5 | | |
| KS8 C2  Komplektid | 1,21 m  | STTIC2 | 5 |  Abiroov 50x100 Kinniti paigaldusvahe max 1,2 m | |
| | 2,25 m  | STTH | 5 | | |
| | 2,97 m  | STTC | 5 | | |
| | 1,21 m  | STTIZC2 | 5 | | |
| | Paigalduskomplektid | 2,25 m  | STTHZ | | 5 |
| | 2,97 m  | STTCZ | 5 | | |
| | Kinniti kivikatus | 31050 | 5 | | |
| KS8D C2  Komplektid | Kinniti kivikatus sirge põhi | 31590 | 10 | Turvaköie saab kinnitada mõlemalt poolt katusesilla. Abiroov 32x100 Abiroov 32x100 | |
| | Esitugi kiviprofiilkatuse kinnitile 31050 | 31680 | 10 | | |
| | Esitoe 31680 alusplaat | 31690 | 10 | | |
| | KS8D C2 Kinniti kivikatus | 30820 | 10 | | |
| Tugiraud abiroov | 30830 | 10 | | | |
| KS ET  Komplektid | 1,21 m  | STTETB | 10 |  Kinniti paigaldusvahe max 1,2 m Eternit 920x585 mm. Muud suurused kasutada abiroov 50x50 mm | |
| | 2,25 m  | STTETC | 10 | | |
| | 2,97 m  | STTET | 10 | | |
| | 1,21 m  | STTETBZ | 10 | | |
| | Paigalduskomplektid | 2,25 m  | STTETCZ | | 10 |
| | 2,97 m  | STTETZ | 10 | | |
| | Kinniti Eternit | 31870 | 10 | | |
| KS CEM  Komplektid | 1,21 m  | STTCEMB | 10 |  Kinniti paigaldusvahe max 1,2 m Cembrit 625 mm | |
| | 2,25 m  | STTCEMC | 10 | | |
| | 2,97 m  | STTCEM | 10 | | |
| | 1,21 m  | STTCEMBZ | 10 | | |
| | Paigalduskomplektid | 2,25 m  | STTCEMCZ | | 10 |
| | 2,97 m  | STTCEMZ | 10 | | |
| | Kinniti Cembrit | 31850 | 10 | | |



LUMETÖKETE DIMENSIONEERIMINE

Nr katuse kalle on 1:1,5 (u 33 kraadi) ja hoone asub kohas, kus lumekoormus on 2 kN/m². Lumetökke maksimaalne kaugus katuseharjast on sellisel juhul 6,8 m. Kui katuseviil on pikem, lisatakse veel üks lumetökkerida. Lumetökkeridade maksimaalne vahe on siis 6,8 m.

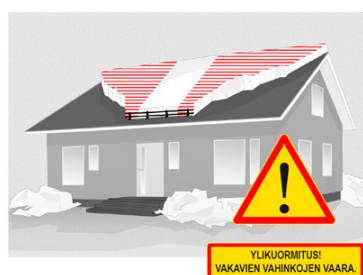
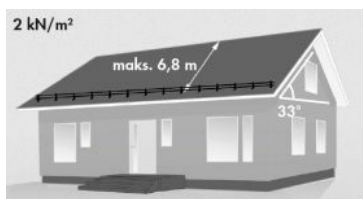











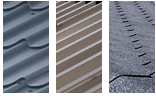

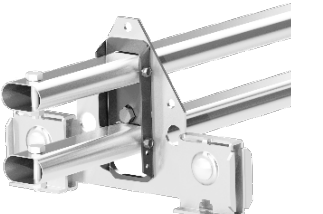
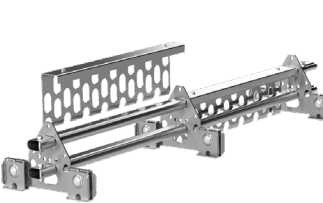
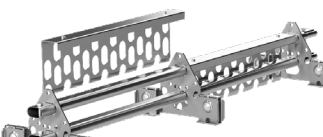
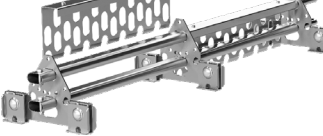
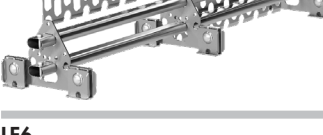



















| Katuse kalle | | | LUMEKOORMUS kN/m ² (~100 kg/m ²) | | | | | |
|--------------|----------|------|---|-------|-------|-------|-------|-------|
| kraadides | suhtarvu | pilt | 1 | 1,5 | 2 | 2,5 | 3 | 3,5 |
| 6° | ~1:10 | | 60 m | 40 m | 30 m | 24 m | 20 m | 17 m |
| 10° | ~1:5 | | 37 m | 24 m | 18 m | 15 m | 12 m | 10 m |
| 14° | 1:4 | | 27 m | 18 m | 13 m | 11 m | 8,9 m | 7,6 m |
| 18° | 1:3 | | 21 m | 14 m | 11 m | 8,5 m | 7,1 m | 6,1 m |
| 23° | ~1:2,5 | | 17 m | 12 m | 8,7 m | 7,0 m | 5,8 m | 5,0 m |
| 27° | 1:2 | | 15 m | 10 m | 7,7 m | 6,2 m | 5,2 m | 4,4 m |
| 33° | 1:1,5 | | 14 m | 9,1 m | 6,8 m | 5,5 m | 4,6 m | 3,9 m |
| 38° | | | 13 m | 8,6 m | 6,4 m | 5,2 m | 4,3 m | 3,7 m |
| 42° | | | 13 m | 8,4 m | 6,3 m | 5,0 m | 4,2 m | 3,6 m |
| 45° | 1:1 | | 13 m | 8,3 m | 6,3 m | 5,0 m | 4,2 m | 3,6 m |
| 50° | | | 13 m | 8,5 m | 6,3 m | 5,1 m | 4,2 m | 3,6 m |
| 55° | | | 13 m | 8,9 m | 6,7 m | 5,3 m | 4,4 m | 3,8 m |
| 60° | | | 14 m | 9,6 m | 7,2 m | 5,8 m | 4,8 m | 4,1 m |

| TOODE | MÖÖDUD | TOOTE NR | TARNE-AEG* | TOOTEKIRJELDUS |
|-------|---------------------------|----------|------------|----------------|
| | Lumetökketoru, ahenev 3 m | 31010 | 5 | |

Standardvärvid **RR20** **RR23** **RR29** **RR32** **RR33** **RR750** **RR2H3** **RR11** **RR21**
 Mattvärv (uus!) +10%: **RR23** **RR2H3** **RR32** **RR33**; erivärv +10%

Paigalduskomplektidesse kuuluvad 4 kinnitiit ning kokupanekuks ja kinnituseks vajalikud kruvid ja mutrid.

| TOODE | MÕÕDUD | TOOTE NR | TARNE-AEG* | TOOTEKIRJELDUS, PAIGALDUSVAHE |
|---|--|--|-------------------|--|
| LE3  | Komplektid | 3 m  | SLEK 5 |  Kinniti paigaldusvahe max 1,2 m |
| | Paigalduskomplektid | 3 m  | SLEKZ 5 | |
| | Kinniti kiviprofiil-, bituumen- ja profiilkatus 420 mm | 30630 5 | | |
| LE2        | Komplektid | 3 m  | SLEA 5 |  Kinniti paigaldusvahe max 1,2 m |
| | Paigalduskomplektid | 3 m  | SLEAZ 5 | |
| | Rivikinniti paigalduskomplekt | | 35640 5 | |
| | Torulumetõkke otsatugi valtsplekkkatuse | | 31800 10 | kinnitile 35640 |
| | Lisalumetõkke torulumetõkkele | 500 mm  | 31560 10 | Masinvalts |
| | Lisalumetõkke torulumetõkkele | 964 mm  | 31580 10 | |
| | Lisalumetõkke torulumetõkkele | 441 mm  | 31810 10 | Weckman Proganiti -katuse |
| Lisalumetõkke torulumetõkkele | 920 mm  | 31820 10 | | |
| LE6  | Komplektid | 3 m  | SLEE 5 |  Kinniti paigaldusvahe max 1,2 m |
| | Paigalduskomplektid | 3 m  | SLEEZ 5 | |
| | Kinniti kiviprofiil-, bituumen- ja profiilkatus | 30530 5 | | |
| LE8   | Komplektid | 3 m  | SLED 5 |  Abiroov 50x100 Kinniti paigaldusvahe max 1,2 m |
| | Paigalduskomplektid | 3 m  | SLEDZ 5 | |
| | Kinniti kivikatus | | 31050 5 | |
| | Kinniti kivikatus sirge põhi | | 31590 10 | |
| Lisalumetõkke torulumetõkkele | 928 mm  | 31830 10 | Ormax-tiilikatuse | |
| LE8D  | Kinniti kivikatus | | 30820 10 | Abiroov 32x100 Kinniti paigaldusvahe max 1,2 m |
| | Tugjraud | | 30830 10 | |
| LE ET  | Komplektid | 3 m  | SLET 10 |  Kinniti paigaldusvahe max 1,2 m Eternit 920x585 mm. Muud suurused kasutada abiroov 50x50 mm |
| | Paigalduskomplektid | 3 m  | SLETZ 10 | |
| | Kinniti Cembrit | | 31870 10 | |
| LE CEM  | Komplektid | 3 m  | SLEN 10 |  Kinniti paigaldusvahe max 1,2 m Cembrit 625 mm |
| | Paigalduskomplektid | 3 m  | SLENZ 10 | |
| | Kinniti Cembrit | | 31850 10 | |

VÕRKLUMETÕKKED

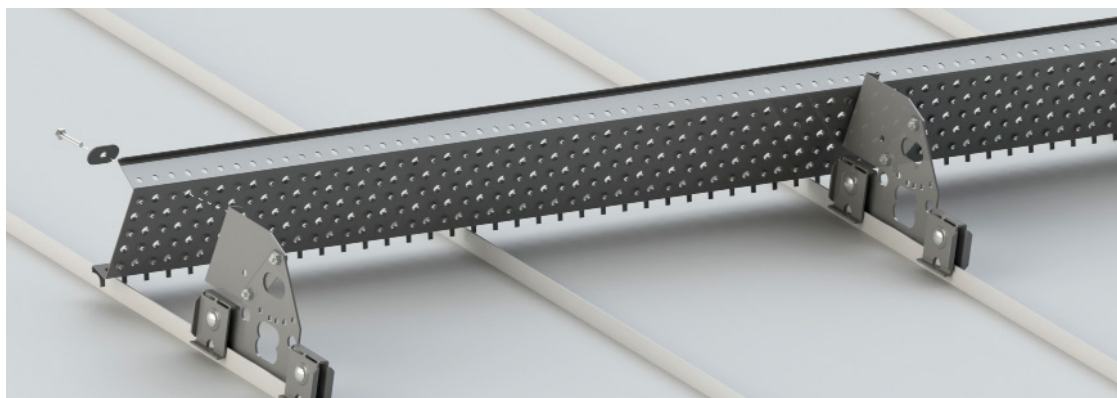

Lumetõkete mõõtmistabel lk 18

| TOODE | MÕÖDUD | TOOTE NR | TARNE-AEG* | TOOTEKIRJELDUS PAIGALDUSVAHE |
|-------|---------------------------------------|----------|------------|------------------------------------|
| | Võrklumetõke 1,23 m | 32010 | 10 | |
| | Võrklumetõke 2,46 m | 32020 | 5 | |
| | Võrklumetõkke pikendusdetail | 32030 | 5 | 1 tk (2 tk/järg) |
| | Võrklumetõkke kidalise servaga 2,46 m | 32190 | 5 | Jätkata ka ülekattega, laius 2,3 m |
| | Võrklumetõkke kinnitusdetail | 32140 | 5 | 1 tk/Katusekinniti |
| | Võrklumetõkke kinnituskomplekt | 35330 | 5 | 1 komplekt/kiinnitusdetail |

Paigalduskomplektidesse kuuluvad 3 kinniti ning kokkupanekuks ja kinnituseks vajalikud kruvid ja mutrid.

| TOODE | MÕÖDUD | TOOTE NR | TARNE-AEG* | TOOTEKIRJELDUS PAIGALDUSVAHE |
|------------------|--|----------|------------|-------------------------------------|
| VLE3 | Paigalduskomplektid 2,46 m | SLVZ | 5 | Kinniti paigaldusvahe max 1,2 m |
| | Kinniti kiviprofiil-, bituumen- ja profiilkatus 420 mm | 30630 | 5 | |
| VLE2 | Paigalduskomplektid 2,46 m | SLVAZ | 5 | Kinniti paigaldusvahe max 1,2 m |
| | Paigalduskomplektid kidalise servaga 2,46 m | SLVCZ | 5 | |
| VLE2H | Rivikinniti paigalduskomplekt | 35640 | 5 | |
| VLE5 | Paigalduskomplektid 2,46 m | SLVEZ | 5 | Kinniti paigaldusvahe max 1,2 m |
| | Kinniti kiviprofiil-, bituumen- ja profiilkatus | 30530 | 5 | |
| VLE8 | Paigalduskomplektid 2,46 m | SLVPZ | 5 | Kinniti paigaldusvahe max 1,2 m |
| | Kinniti kivikatus | 31050 | 5 | |
| | Kinniti kivikatus sirge põhi | 31590 | 10 | |

Standardvärvid **RR20** **RR23** **RR29** **RR32** **RR33** **RR750** **RR2H3** **RR11** **RR21**



Mattvärvid (uus!) +10%: **RR23** **RR2H3** **RR32** **RR33**; erivärvid +10%







KATUSEPIIRETED

Püstude kinnitusvahe maks. 1,2 m. Üldpiirde kinnitite vahe maks. 1,5 m ja üldpiirde lumetõkke kinnitite vahe maks. 1,2 m.
 Katusepiirete komplektid kuuluvad ovaaltorud, püsti- ja kaldtoed, vajalik arv kinniteid ning vahendid monteerimiseks ja katusele kinnitamiseks.

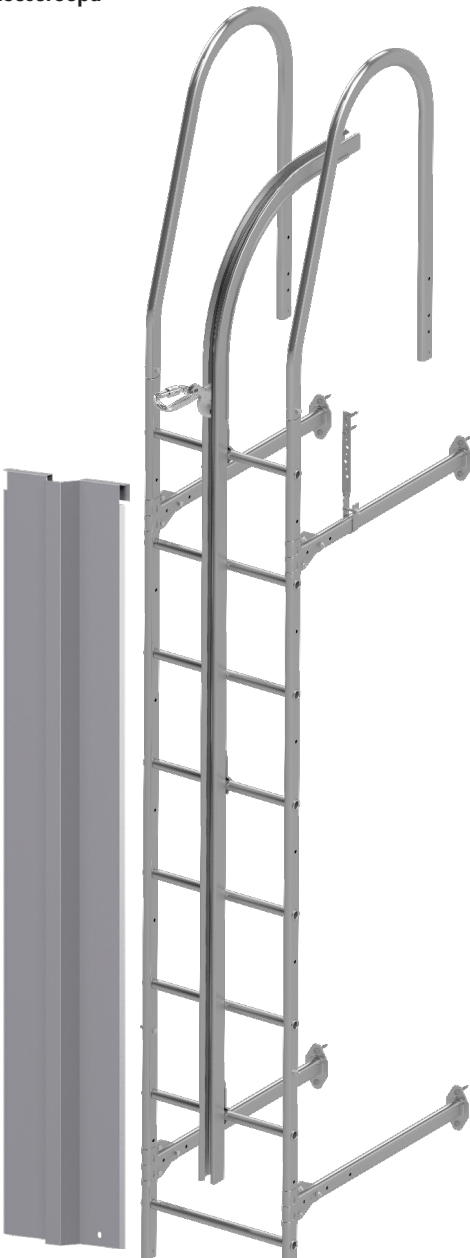



| TOODE | MÕÖDUD | TOOTE NR | TARNE-AEG* | TOOTEKIRJELDUS, PAIGALDUSVAHE |
|----------------|---|-----------------|------------|-------------------------------|
| SYP | Komplektid Laius 3 m Kõrgus 0,6 m | SYP | 10 | |
| SYV | Komplektid Laius 3 m Kõrgus 0,6 m | SYV SYVL | 10 10 | |
| SYO | Komplektid Lumetõketega Laius 3 m Kõrgus 1,1 m | SYO SYOL | 10 10 | |
| SYT | Komplektid Laius 3 m Kõrgus 0,6 m | SYT SYTL | 10 10 | |
| SYS | Komplektid Lumetõketega Laius 3 m Kõrgus 1,1 m | SYS SYSL | 10 10 | |
| SYR | Komplektid Laius 3 m Kõrgus 0,6 m | SYR SYRL | 10 10 | |
| SYN | Komplektid Lumetõketega Laius 3 m Kõrgus 1,1 m | SYN SYNL | 10 10 | |

TURVARÖÖPAD



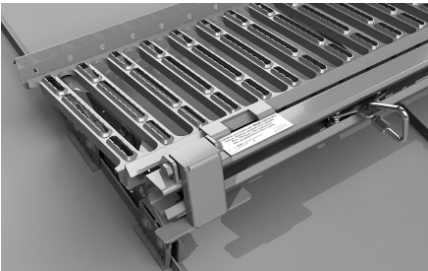







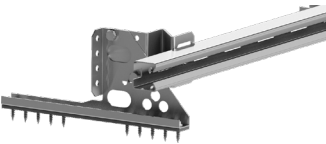

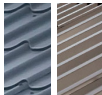





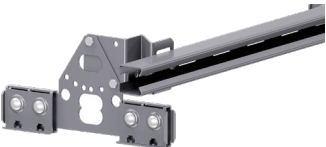

| TOODE | MÖÖDUD | TOOTE NR | TARNE-AEG* | TOOTEKIRJELDUS |
|--|---|----------|------------|--|
| Turvarööbas | | | | |
|  Turvarööbas | 3,0 m  | 33800 | 5 | Sama rööbas tõusu- ja horisontaalrööpaks |
| Pikenduskomplekt | | 33840 | 5 | |

| TOODE | MÖÖDUD | TOOTE NR | TARNE-AEG* | TOOTEKIRJELDUS |
|---|---|----------|------------|--|
| Tõusurööpa | | | | |
|  Tõusurööpa | | | | |
| Tõusuvanker RST | | | | Kasutaja kaal: 40-160 kg Kasutajate vaheline kaugus vähemalt 6 m CE |
|  | | 33880 | 5 | |
| Evakuatsioonikaar | 2,6 m  | 33870 | 5 | |
| Evakuatsioonikaar komplekt külgsuunas | | | | Sama kaar paremale ja vasakule. |
|  | 1 m  | 33780 | 10 | |
| Pulkkinnitite komplekt, RST | | | | Paigaldusvahe max. 1,5m |
|  | | 33860 | 5 | |
| Tõusurööpaga redeli turvapuur | 2,1 m  | 20340 | 10 | |
| Tõusurööpa tüübilist | | 33900 | 5 | kohustuslik |

Standardvärvid RR20 RR23 RR29 RR32 RR33 RR750 RR2H3 RR11 RR21
 Mattvärvid (uus!) +10%: RR23 RR2H3 RR32 RR33 ; erivärvid +10%

| TOODE | TOOTE NR | TARNE-AEG* | | TOOTEKIRJELDUS | |
|---|---|---|-------|----------------|---|
| Horisontaalrööba | | | | | |
|  | Vanker, RST |  | 33850 | 5 | Kasutaja kaal koos varustusega: maks. 120 kg Kasutajate vaheline kaugus vähemalt 3 m |
|  | Turvarööpa kinnituskomplekt katusesillale | | 33890 | 5 | Üks rida: 2 tk/turvarööpa + 2 tk |
|  | Vabastatav vankritöke | | 33810 | 5 | |
| | Fikseeritud vankritöke | | 33820 | 5 | |
|  | Horisontaalrööpa seinakinnite komplekt | | 33830 | 5 | Paigaldusvahe max. 2,0 m |
| | Horisontaalrööpa tüübisilt | | 33910 | 5 | Kohustuslik |

HOOLDUSRÖÖBASTE PAKETID

| TOODE | MÕÖDUD | TOOTE NR | TARNE-AEG* | TOOTEKIRJELDUS, PAIGALDUSVAHE |
|--|---|----------|------------|--|
|  | Komplektid 3 m  | PHK3016 | 10 |  Kinniti paigaldusvahe max 1,2 m |
| | Kinnituskomplektid 1 tk  | PHKL16 | 10 | |
|  | Komplektid 3 m  | PHK3013 | 10 |  Kinniti paigaldusvahe max 1,2 m |
| | Kinnituskomplektid 1 tk  | PHKL13 | 10 | |
|  | Komplektid 3 m  | PHK3014 | 10 |  Kinniti paigaldusvahe max 1,2 m |
| | Kinnituskomplektid 1 tk  | PHKL14 | 10 | |
|  | Komplektid 3 m  | PHK3012 | 10 |  Kinniti paigaldusvahe max 1,2 m |
| | Kinnituskomplektid 1 tk  | PHKL12 | 10 | |
|  | Komplektid 3 m  | PHK3015 | 10 |  Kinniti paigaldusvahe max 1,2 m |
| | Kinnituskomplektid 1 tk  | PHKL15 | 10 | |

LUMETÖKKED



LE3

KIVIPROFIILPLEKK, PROFIILPLEKK, BITUUMEN



LE2

VALTSPROFIIL

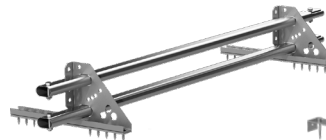

LE6

PROFIILPLEKK, BITUUMEN



LE8

KIVIKATUS

VÖRKLUMETÖKKED

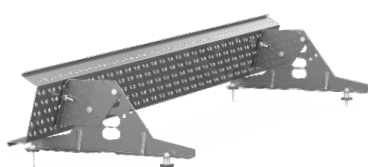

VLE3

KIVIPROFIILPLEKK, PROFIILPLEKK, BITUUMEN

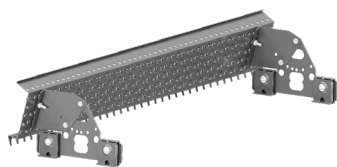

VLE2H

VALTSPROFIIL

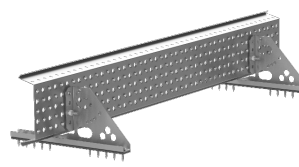

VLE5

PROFIILPLEKK, BITUUMEN



VLE8

KIVIKATUS

KATUSESILLAD

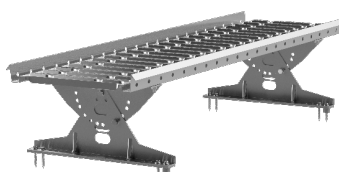

KS4C2

KIVIPROFIILPLEKK, PROFIILPLEKK, BITUUMEN

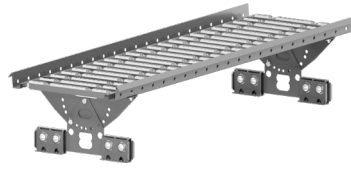

KS3C2

VALTSPROFIIL

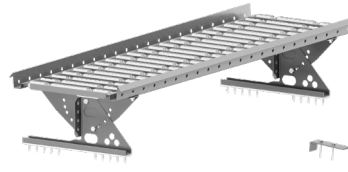

KS7C2

PROFIILPLEKK, BITUUMEN



KS8C2

KIVIKATUS

KATUSEPIIRETED

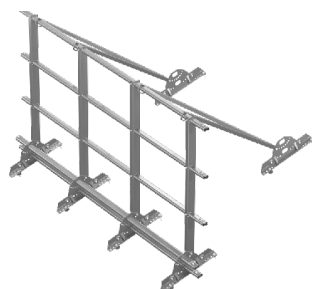

SYOL

KIVIPROFIILPLEKK, PROFIILPLEKK, BITUUMEN



SYN

VALTSPROFIIL

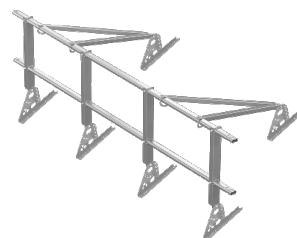

SYT

KIVIPROFIILPLEKK, PROFIILPLEKK, BITUUMEN



SYRL

VALTSPROFIIL